



V-BOX MARK-II

MONO PASSIVE DIRECT BOX



USER MANAUL

WWW.VL.CO.TH

INTRODUCTION

DESCRIPTIONS

The V-Box Mark-II Mono Passive Direct Box Is a high performance passive direct box for live concert touring and professional studio recording applications, featuring a VL transformer for exceptional audio performance.

FEATURE

- Mono passive direct box designed for active instruments.
- Eliminates hum and buzz from ground loops.
- VL Transformers provide exceptionally linear response.

OVERVIEW

1. **Line-Level Outputs** Balanced output, Male XLR Connectors.
2. **Ground/Lift Switch** Disconnects XLR Pin-1 on INPUT.
3. **Pad** Reduces The input sensitivity for active basses and high-output keyboards.
4. **1/4" Input** Instruments connection to The V-Box Mark-II Mono Passive Direct Box.
5. **1/4" Thru** Instruments thru-put to an amplifier.

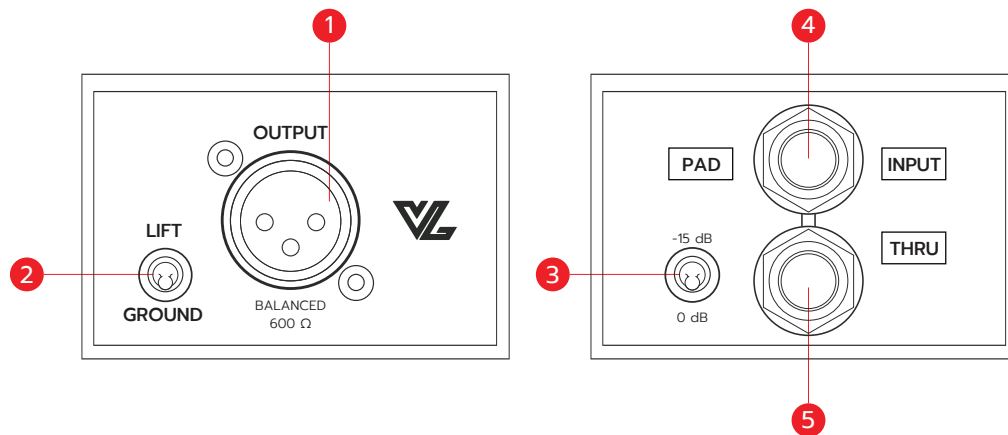

BLOCK DIAGRAM

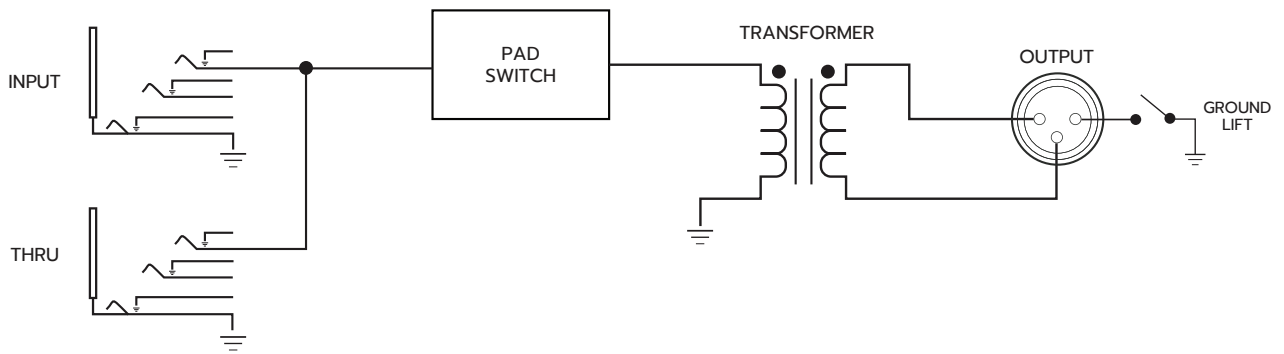

APPLICATION

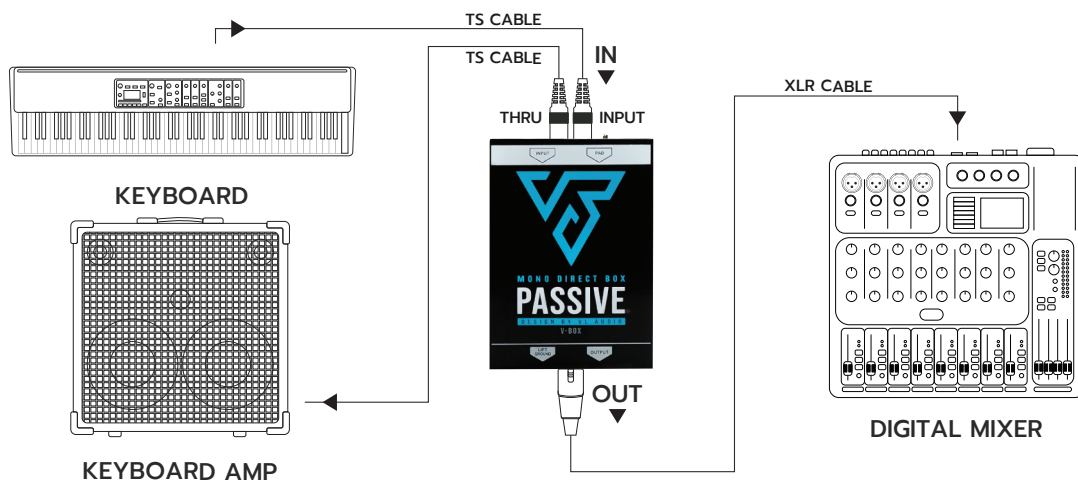
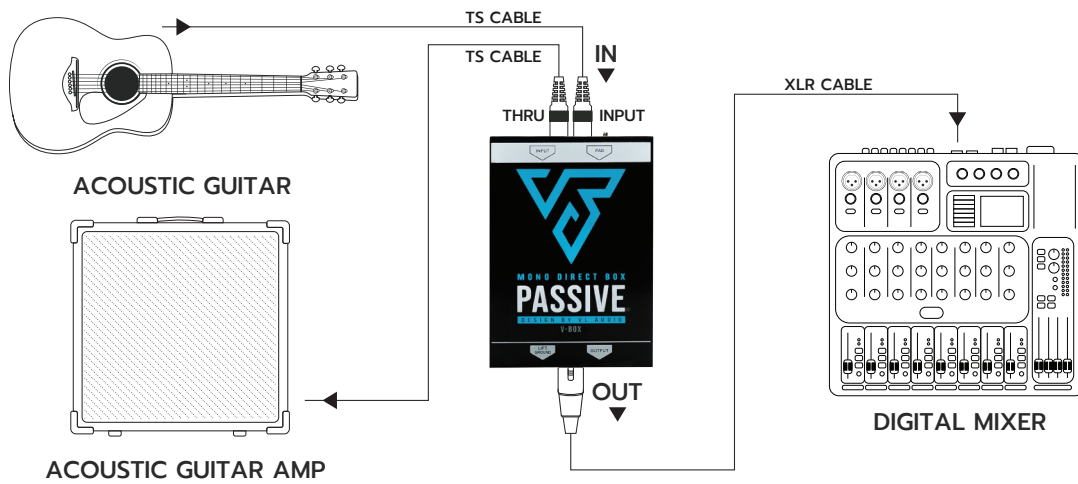
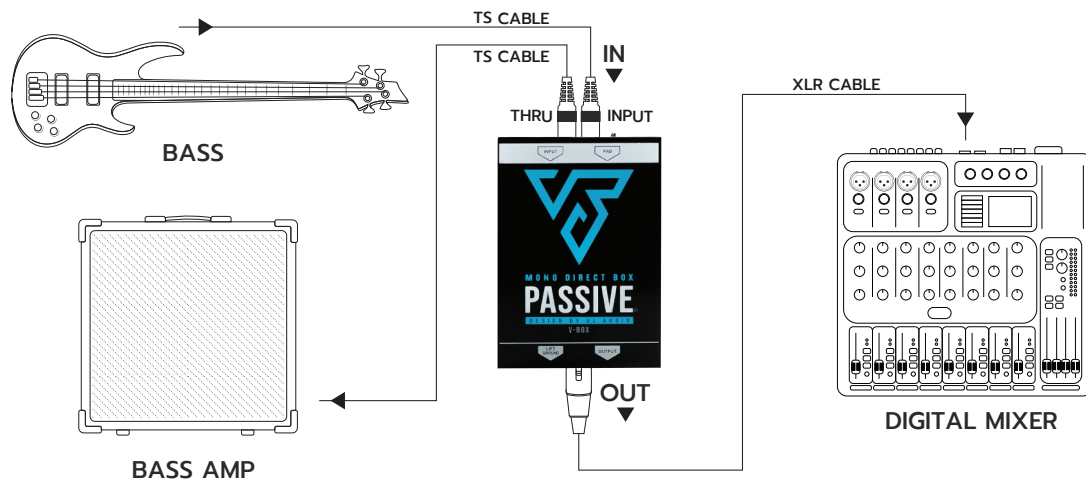

TECHNICAL SPECIFICATION

SPECIFICATIONS

Audio circuit type	Passive, Transformer based
Transformer	VL Transformer
Number of Channels	Mono
Frequency response	20Hz-20kHz
Dynamic range	135dB
Total harmonic distortion	0.002% @1k, +4dBu
Phase deviation	-1.45° @20Hz, -0.5° @100Hz
Input impedance	140kΩ Unbalanced
Output impedance	600Ω Balanced
Maximum input	+21dBu @20Hz - 20kHz (With Pad)

FEATURES

Ground lift	Yes
Input connectors	2 TS 1/4" (1 Thru)
Output connectors	2 XLR Male outputs

GENERAL

Conditions	For use in dry locations only
Warranty	Life time

SIZE

Height	48mm
Width	69mm
Depth	97mm
Weight	0.25kg

SHIPPING INFORMATION

Package height	52mm
Package width	92mm
Package depth	122mm
Package weight	0.35kg

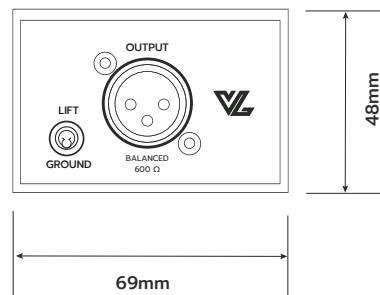
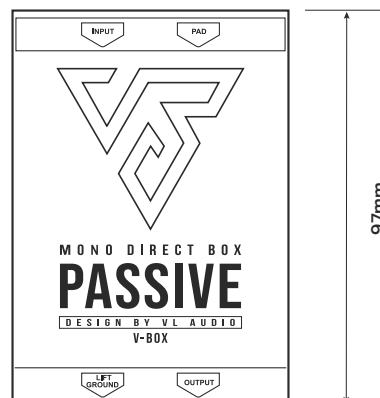

MONO PASSIVE DIMENSIONS